

MORE FEATURES FOR WINDOWS



more

OKNOPLAST

OKNOPLAST is definitely... more.

Experience a new level of quality with our uPVC solutions. Our passion and experience allow us to offer products that meet the highest expectations. Our Tilt&turn windows, sliding patio doors, and front doors are made from the highest quality uPVC and are optimized for energy efficiency. This not only helps reduce heating bills but also benefits the environment. Our products provide excellent thermal and acoustic insulation, making your place a haven of peace and comfort. OKNOPLAST extends beyond windows; it's a dedication to enhancing living standards through our premier uPVC solutions, where quality, energy efficiency, and comfort seamlessly converge.

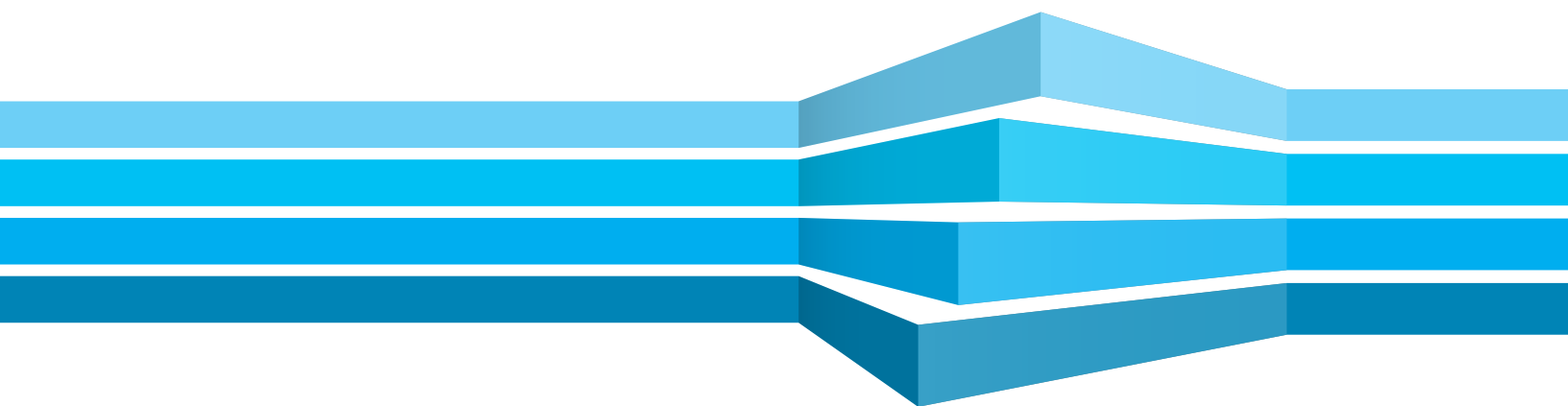

TABLE OF **CONTENTS**

Key facts	4
What makes our products DIFFERENT?	6
TILT & TURN WINDOWS	9
uPVC WINDOWS	12
uPVC PATIO DOORS	18
uPVC FRONT DOORS	60
Our certification	68





WHO **WE ARE.**

**Passion for Creation.
The latest technological solutions.
Design focused on changing needs.**

OKNOPLAST is one of the leading window & door brands in Europe, providing both residential and commercial high-performance products. With a strong position in the European market, we are reaching overseas to bring new premium-quality windows and doors to American customers.

More Features For Windows. The OKNOPLAST philosophy. OKNOPLAST offers original window and door solutions. The products are advanced, energy efficient, and crafted with great precision and epitomize the aesthetic of unique workmanship. Windows and doors manufactured by OKNOPLAST meet both the highest quality, and ecological standards.

KEY **FACTS.**

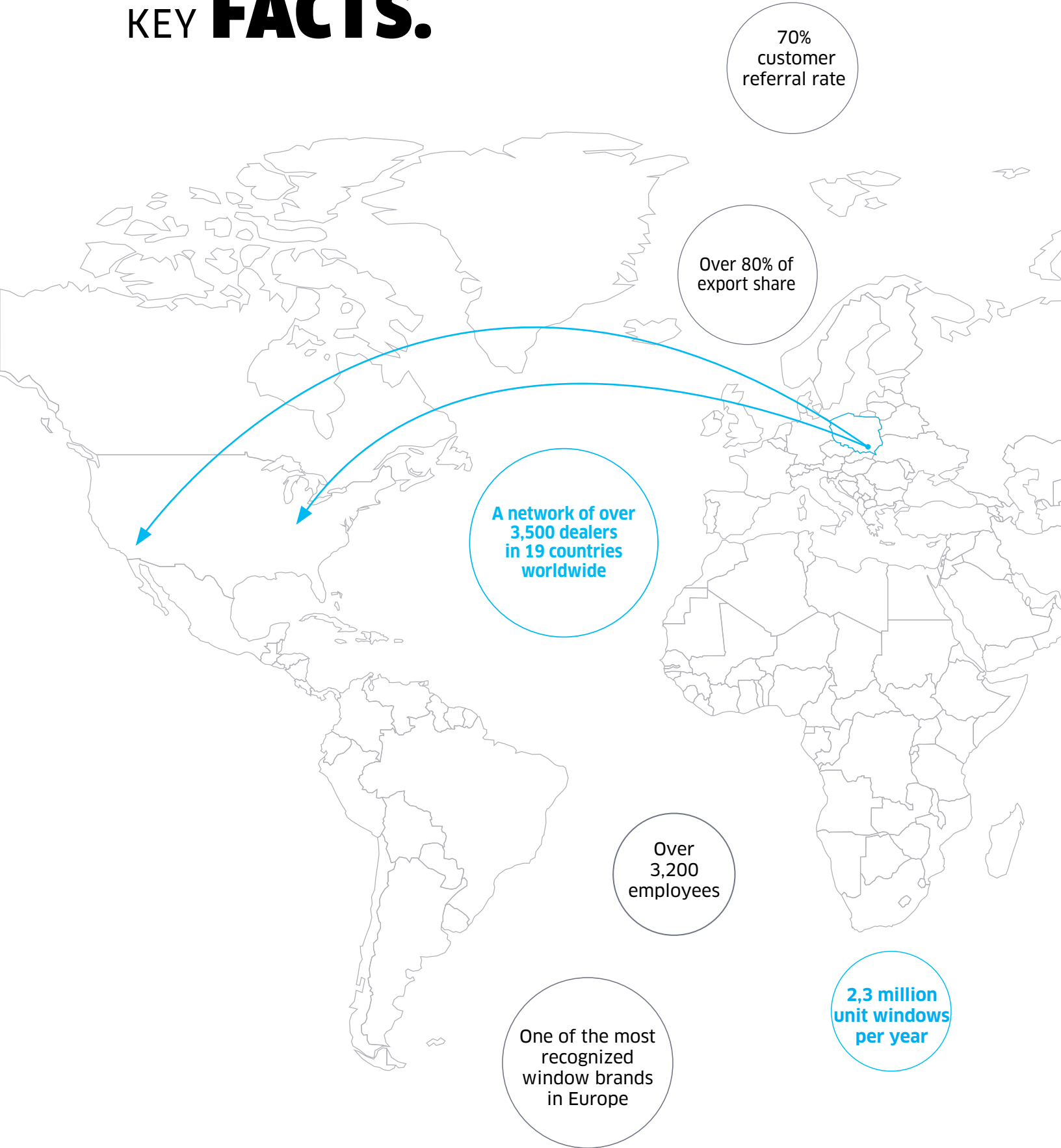

70%
customer
referral rate

Over 80% of
export share

A network of over
3,500 dealers
in 19 countries
worldwide

Over
3,200
employees

One of the most
recognized
window brands
in Europe

2,3 million
unit windows
per year

WHAT MAKES TILT AND TURN WINDOWS DIFFERENT?



EXCLUSIVE PREMIUM WINDOWS AND DOORS.

Our windows and doors are exclusively engineered and designed for the best performance and look.

CUSTOMIZATION

We customize shape, color, and other unique features based on customer needs.





HIGH **QUALITY**

Strict manufacturing standards and high quality components make our windows and doors the first choice for customers with high expectations.



PIXEL window

HIGH PERFORMANCE AND FUNCTIONALITY.

Our windows go above and beyond. Even our standard windows exceed customer expectations in performance and functionality.



DISCOVER MORE FEATURES
FOR **WINDOWS** AND TAKE YOUR
HOME TO THE **NEXT LEVEL**

FEATURES
THAT MAKE YOUR LIFE
more **SIMPLE**

VENTILATION.
CLEANING.
EASY-TO-USE HANDLE.
BETTER FIT.

FEATURES
THAT MAKE YOUR LIFE
more **SAFE**

INCREASED PROTECTION.
PROTECTION AGAINST INSECTS.
REINFORCED STRUCTURE.
WINDOW BLOCKAGE.

FEATURES
THAT MAKE YOUR LIFE
more **BEAUTIFUL**

MODERN DESIGN.
PERSONALIZED SHAPE.
FLEXIBLE DIMENSION.
COLORS.

FEATURES
THAT MAKE YOUR LIFE
more **EFFICIENT**

NOISE REDUCTION.
SUN PROTECTION.
HEAT TRANSFER COEFFICIENT.
SUSTAINABLE DEVELOPMENT.

HOW IT WORKS – ONE HANDLE

Two functions. Endless comfort.



Tilt for ventilation

Turn the handle 90° to tilt the window inward at the top.



Let fresh air in



Maintain security

Turn for full access

Turn the handle 180° to fully open the window inward.



Easy cleaning



Maximum airflow

TILT & TURN WINDOWS

secure. simple. smart.



more
SECURITY

Multi-point locking.
Stay safe even when tilted.



smart
VENTILATION

Fresh air without compromising safety.



energy
EFFICIENCY

Save on bills with Low-E glass
and insulation.



easy
MAINTENANCE

Inward opening = effortless cleaning.

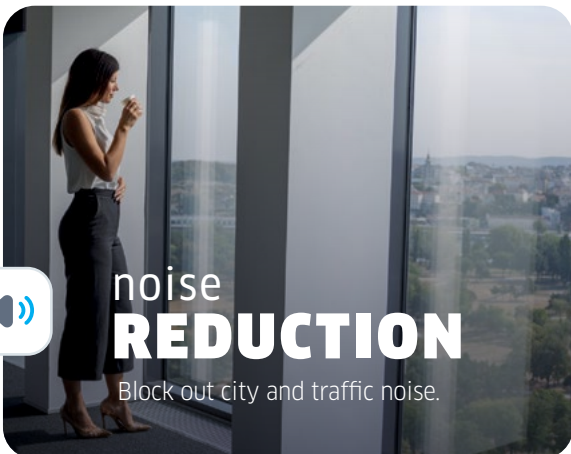

noise
REDUCTION

Block out city and traffic noise.

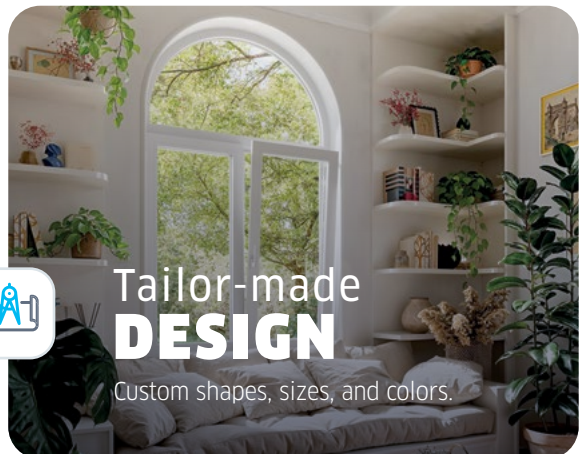

Tailor-made
DESIGN

Custom shapes, sizes, and colors.

TILT AND TURN WINDOWS MADE FOR PEOPLE LIKE YOU

Tilt and Turn windows are designed for everyone - from luxury villas and modern apartments to traditional American homes and commercial spaces. Whether you're building your dream home or upgrading your current one, OKNOPLAST Tilt and Turn windows adapt to your lifestyle. Discover which benefits matter most to you.



Families with children

Safe, quiet, and worry-free.

Let in fresh air without opening the entire window. Keep your loved ones safe while enjoying a peaceful, well-ventilated home.

- Secure tilt function
- Noise reduction
- Easy, safe ventilation



Seniors and comfort-seekers

Comfort and simplicity in everyday use.

Open and clean windows effortlessly with a single handle – no lifting, no strain.

- One-handle operation
- Easy cleaning from the inside
- Inward-opening for convenience



Pet lovers

Fresh air for them. Peace of mind for you. Tilt mode keeps curious pets safe while still allowing airflow – no wide-open windows needed.

- Controlled ventilation
- Safe for animals
- Bottom stays securely closed



Eco-conscious homeowners

Smart design that's good for your home and the planet. Reduce your energy bills and carbon footprint – all while enjoying a brighter, more efficient space.

- High insulation & Low-E glass
- More natural light
- Sustainable European engineering



New homeowners and renovators

Modern style meets ultimate performance. Choose from a wide range of shapes, sizes, and colors to fit your architectural vision.

- Fully customizable
- Sleek, European design
- Built to last

UPVC **WINDOWS**



PIXEL

Tilt and Turn PIXEL window is equipped with a 6-chamber profile and bent-steel reinforcement to ensure a stable structure. The support from the stable structure allows for the creation of a more expansive view despite the slender window profiles. The technical and operational parameters of the PIXEL system are highly advanced.

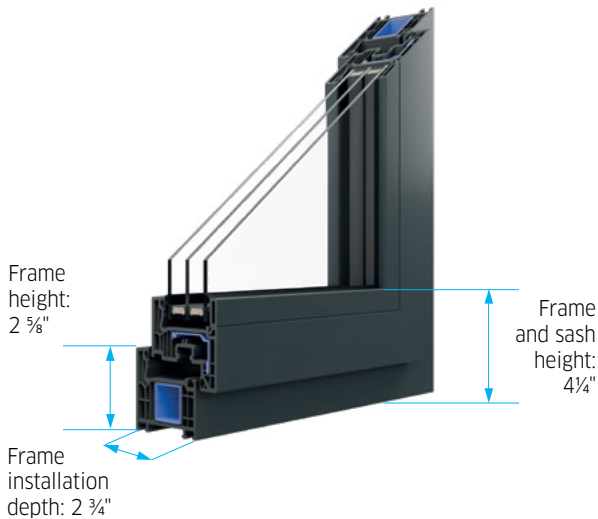

THERMAL TRANSMITTANCE

U-Factor = 0.16-0.29*



SOUND TRANSMISSION CLASS

STC = 32-46 OITC 26-39*



DESIGN PRESSURE

DP = 30-90*



**HVHZ & FLORIDA
PRODUCT APPROVAL****



**ADA STANDARDS
COMPLIANT**



Smart
OKNOPLAST

Integrated nailing fin with mounting holes. Ability to use uPVC Brickmould.

*Tested or calculated parameters depending on construction type and element dimensions.
**DP-90 for Tilt and turn window of size 59.84" x 65.94"



PIXEL window

UPVC WINDOWS



PAVA

Tilt and Turn PAVA window is a combination of the time-tested, multi-chamber, European window profile systems and steel reinforcements. Additionally, the STV dry glass bonding technology significantly increases the rigidity and stability of the structure. Due to the bonding technology, the glass and the profile become one element. The glass, which is a very rigid material, takes a large part of the structural weight onto itself. The central gasket guarantees even greater tightness, as well as thermal and acoustic insulation.

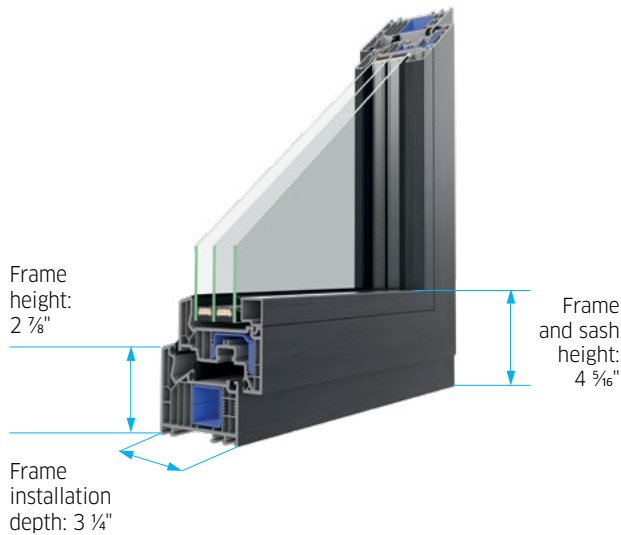

THERMAL TRANSMITTANCE

U-Factor = 0.14-0.26*



SOUND TRANSMISSION CLASS

STC = 32-46 OITC 26-37*



DESIGN PRESSURE

DP = 30-80*



RECOMMENDED BY PHIUS FOR PASSIVE HOUSE



Smart
OKNOPLAST

Integrated nailing fin with mounting holes. Ability to use uPVC Brickmould.

*Tested or calculated parameters depending on construction type and element dimensions.



PAVA window

UPVC WINDOWS



PIXEL

- Rectangular, sharply defined profile edges and glazing beads.
- Sleek and elegant 6-chamber frame profiles and class A sashes.
 - Proprietary, patented system of steel reinforcements.



PAVA

- Unique, modern design for the sash profile.
- 7-chamber frame profile and 6-chamber sash profile of class A.
 - Choose between PIXEL or KONCEPT glazing bead options.
- Static dry glazing technology (STV) enhances sash statics and rigidity.
- Middle gasket in the frame increases thermal and acoustic insulation, along with two anti-burglar latches.

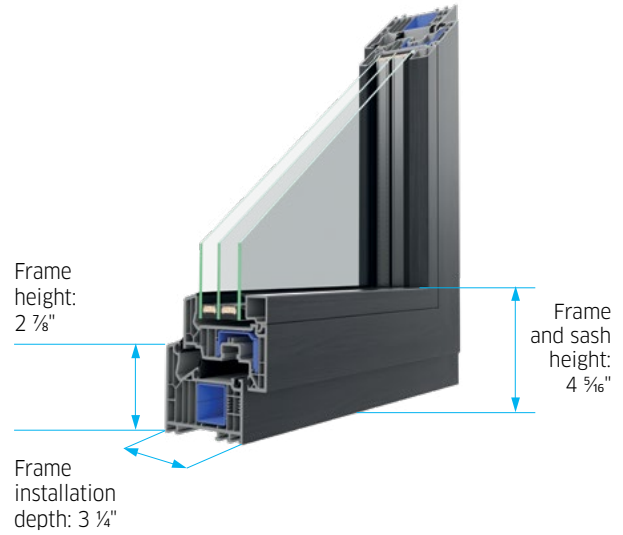
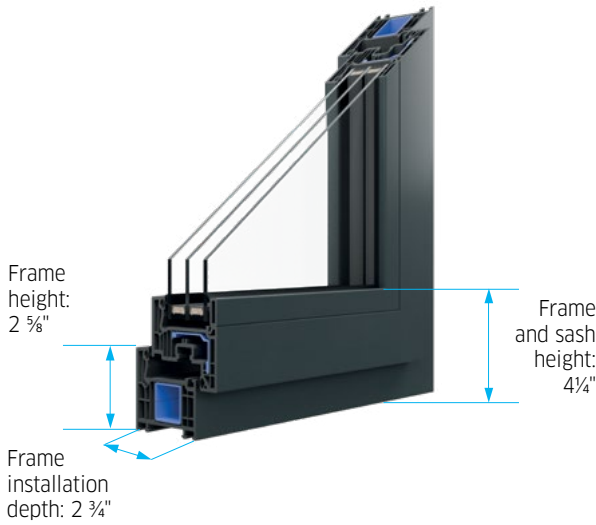

MAXIMUM SASH HEIGHT*
102 1/2"



MAXIMUM SASH WIDTH*
56"



MAXIMUM SASH HEIGHT*
102 1/2"



MAXIMUM SASH WIDTH*
56"

*Tested or calculated parameters depending on construction type and element dimensions.



UPVC **PATIO DOORS**

HORIZON LIFT & SLIDE PATIO DOOR

HORIZON LIFT&SLIDE PATIO DOOR fit perfectly into the trend of large glazing in modern architecture. The goal of the door's design was to create brighter home interiors. The sash area can be up to 67 ft² and the large glazing in lowered leaf profiles provide more natural light in rooms. By incorporating the excellent stability of the structure, obtained through to the steel reinforcements, the low threshold, flush with the floor, and the easy-to-use micro-ventilation, which ensures optimal air exchange in the room, we've created the perfect patio door.

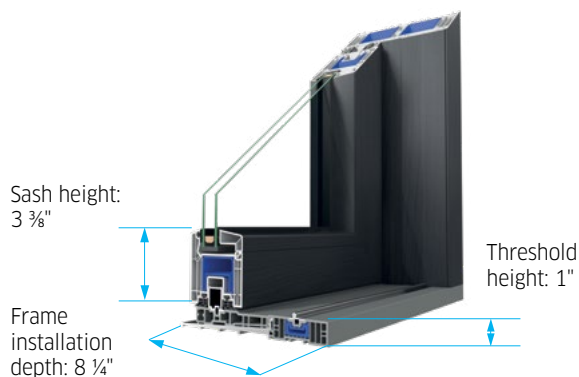

THERMAL TRANSMITTANCE

U-Factor = 0.18-0.29*



SOUND TRANSMISSION CLASS

STC do 37-40 OITC 27-34*



DESIGN PRESSURE

DP = 30-60*



ADA STANDARDS COMPLIANT



Smart
OKNOPLAST

*Tested or calculated parameters depending on construction type and element dimensions.



HORIZON patio door

UPVC **PATIO DOORS**



COMPACT PATIO DOOR

Sliding **COMPACT PATIO DOORS** have an innovative mechanism ensuring easy and intuitive operation. Stability and the ability to create large structures ensure a wide range of possibilities. With a minimalistic design you have the opportunity to maximize the glazed surface, allowing for more natural light in the room.

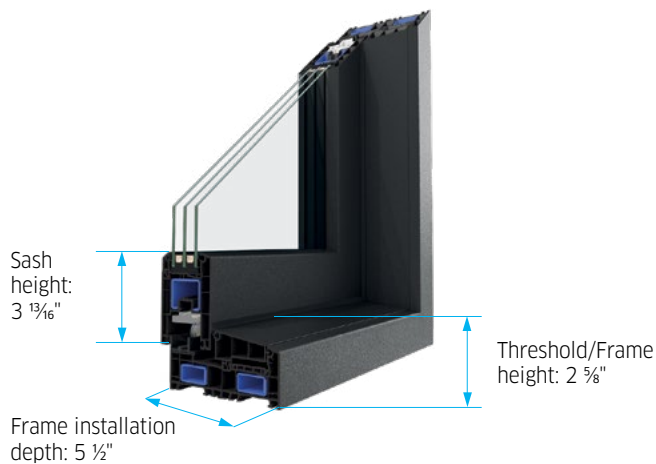

THERMAL TRANSMITTANCE

U-Factor = up to 0.17*



SOUND TRANSMISSION CLASS

STC = 35 OITC 28*



DESIGN PRESSURE

DP = 50*



ADA STANDARDS COMPLIANT

*Tested or calculated parameters depending on construction type and element dimensions.



COMPACT patio door

UPVC PATIO DOORS



HORIZON LIFT AND SLIDE PATIO DOOR

- Lift & slide technology for stable and lightweight system operation.
- Micro-ventilation - a window setting that unseals the sash from the frame and provides optimal air exchange.
 - Optional ADA compliant threshold.

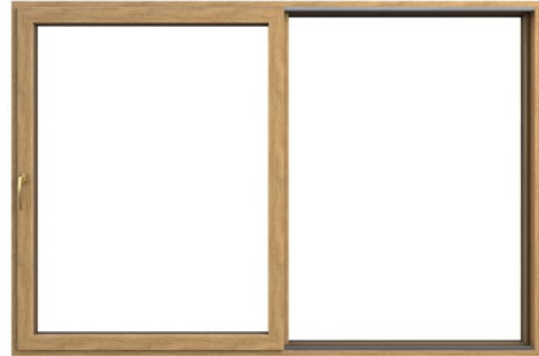

COMPACT PATIO DOOR

- Sliding technology provides a lightweight system.
- Special fittings ensure smooth sash sliding on rollers after unlocking relative to the stationary structural elements.
 - The locking mechanism enables gentle sash closing.

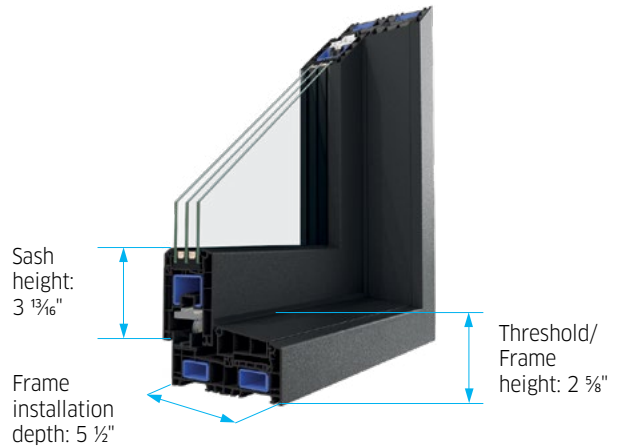
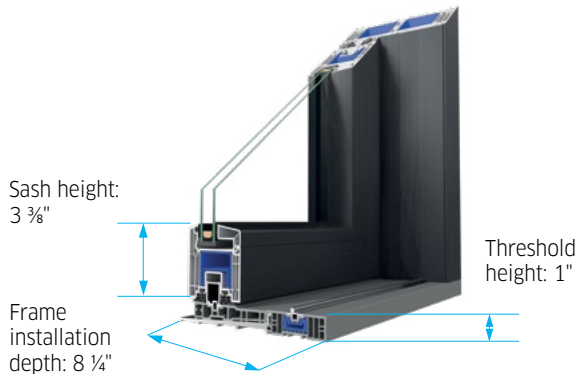

MAXIMUM FRAME HEIGHT*
106"



MAXIMUM FRAME WIDTH*
236"



MAXIMUM FRAME HEIGHT*
102"



MAXIMUM FRAME WIDTH*
157"

*Tested or calculated parameters depending on construction type and element dimensions.



HORIZON patio door





more

BEAUTIFUL

Discover our vision of beauty, where aesthetics are as important as functionality and safety. With OKNOPLAST systems, you have the freedom to personalize every aspect of your windows. From shape and size to color and final appearance, create a solution that reflects your unique style. Enhance a modern profile with a rich color palette, stylish accessories, and exquisite details. At OKNOPLAST, we believe that true beauty is found in the meticulous attention to detail.

FEATURES

THAT MAKE YOUR LIFE

more **BEAUTIFUL**



COLORS

Thoughtful window composition and color can determine the final aesthetic of your spaces. See the possibilities of our windows in different styles. You can choose from 50 veneer colors.

CLASSIC

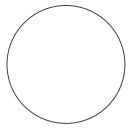

white*



brilliant white



black jet matt



dark gray



anhracite grey ALUX DB-703



smooth anhracite grey

WOOD



sheffield oak



winchester



golden oak



walnut



anhracite wood



siena rosso



dark oak

 woodec
dark toffee

MATTE



white matt



basaltgrau matt



fenstergrau matt



quarzgrau matt



umbragrau matt



kitami dark matt



s-bronze matt

METAL



brushed aluminium



anhracite quartz

There are a wide range of different additional window color combinations you can choose from.

* unveneered color

** veneer with wooden surface effect

UPVC WINDOWS



UNIQUE SHAPES

Round, half-round, triangular, or other - you decide the final shape. Even uniquely shaped windows can feature the Tilt and Turn function, allowing them to tilt for ventilation or swing open for easy access. Plus, you can choose from over 50 different window color combinations to match your style perfectly.

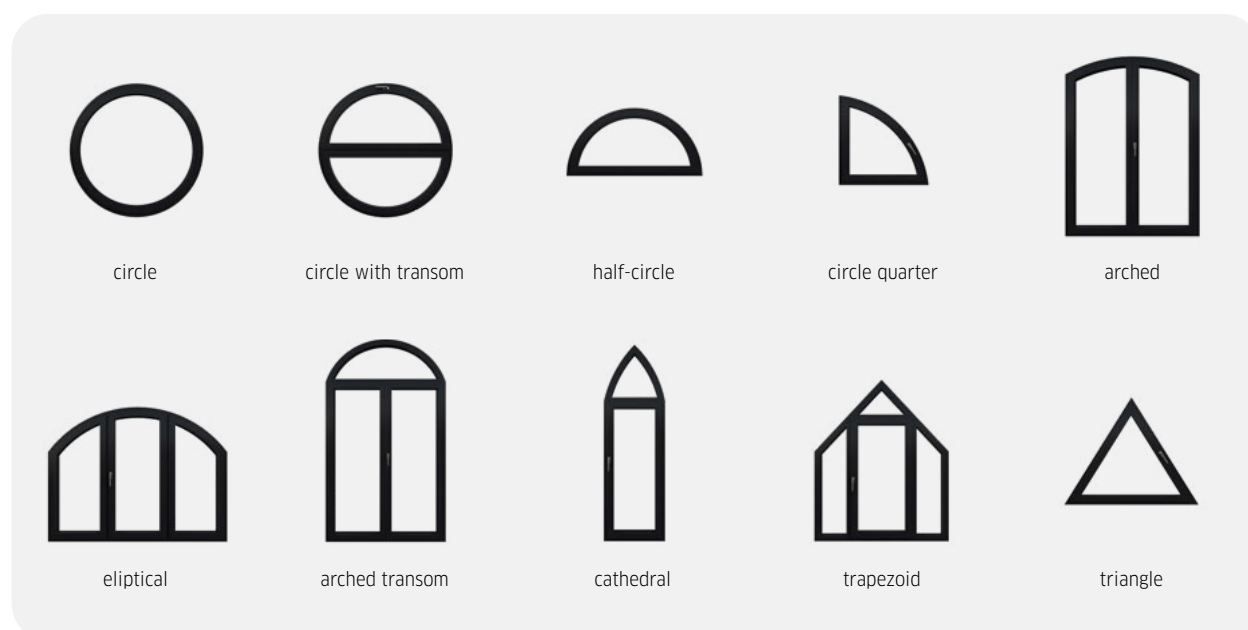



ORNAMENTAL GLASS

Ornamental glass allows light to permeate the interior of the room, increasing its warmth and depth while maintaining privacy.



cathedral



chinchila clean



delta mat

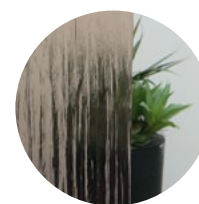

kura brun

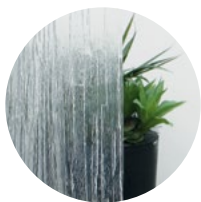

kura clean

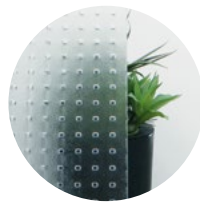

master carre



master ligne

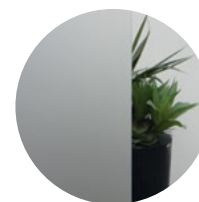

satinato

UPVC **WINDOWS**

GRILLES

Grilles are decorative slats, visually dividing the glass into several parts. They are available in in-pane or glued-on variants, and come in different widths and colors. Thanks to the large variety of possible combinations, you create a unique appearance for any interior.



simulated divided lites with duplex



simulated divided lites without duplex



grilles between glass

COLORS

There are a wide range of different additional grilles color combinations you can choose from. The color of the grilles is matched to the color of the window or to the customer's preference.

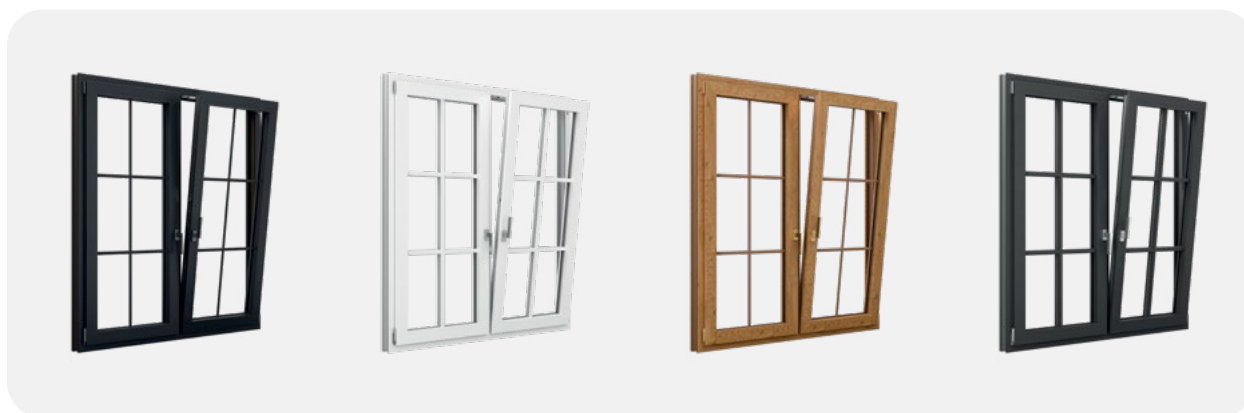

A close-up photograph of a window handle and its internal mechanism. The handle is a light-colored, elongated piece with a circular grip and a small rectangular slot. It is mounted on a dark grey or black metal frame. The background is a bright yellow wall with a fine, grid-like texture. The lighting is dramatic, casting shadows and highlighting the metallic surfaces.

more

SIMPLE

OKNOPLAST's advanced technology makes everyday life simpler. Our systems are distinguished by intuitive operation and trouble-free functioning. What does simpler mean to us? The tilting system in the window allows free and safe ventilation without drafts. Full side opening of the sash means simpler and faster cleaning of the system. Functional accessories like our handle, low sill, and smart solutions are the perfect fit for your needs. It simply couldn't be easier.



FEATURES

THAT MAKE YOUR LIFE

more **SIMPLE**



EASY OPERATING HANDLE

All window functions, **opening, tilting for ventilation, and closing for micro-ventilation**, are possible with one ergonomic handle. The shape and color choice is yours.



ONIX

The ONIX window handle is crafted from durable aluminum, ensuring smooth operation in everyday use. Its geometric design pays homage to timeless solutions. The handle is available in several versions: with a key for enhanced security, with a button for ease of use, or in a TBT version to minimize the risk of accidental opening of the sash.



light gold F3

gold F4

titanium F9

silver F1

black 9005 matt

brown

white

PIXEL

The PIXEL handle has a square shape which highlights the simple and elegant profile of the window.



light gold F3

gold F4

graphite F9

silver F1

black 9004

brown

white

UPVC ACCESSORIES

DESIGN+

The modern dESIGN+ handle has been designed in collaboration with the renowned design studio KISKA and is exclusively available under the OKNOPLAST brand. Its shape gives it a contemporary, minimalist character. The handle is durable and comfortable to use. With its versatile shades, it seamlessly fits into both modern and traditional interiors. It is also available in a key version.



SLEEK

Designed in accordance with minimalist trends, the SLEEK handle is a solution dedicated to modern interiors and designer window systems. Made of durable aluminum, it will maintain its unchanging shape and smooth functionality for many years. The handle's unique character is determined by the nearly invisible rosette. Choose between the classic, streamlined design or the geometric, industrial-style model of the SLEEK handle that will accentuate your style.

SLEEK



SLEEK+



BALCONY LATCH (WIN CLICK)

A hardware component that allows you to comfortably close the balcony door from the outside. The balcony latch is equipped with an elegant and ergonomic handle with an original design and exceptional durability. The handle is made of aluminum.

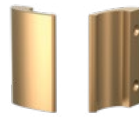

gold F4



graphite F9



silver F1



silver



stainless steel



anthracite RAL 7016



brown RAL 8019



black RAL 9005



white RAL 9016



IMPACT RATED WINDOWS

Our Tilt and Turn windows are hurricane rated. This means, our glass is thoroughly tested and specially treated to be less likely to shatter or break loose from the window frame in the event of a hurricane or violent windstorm. Our windows are rated DP-90 meaning they can withstand a category 5 hurricane*.

* PIXEL 59" x 65 1/2" Tilt and Turn Window with 1/4" + 1/4" Float Saflex VS02 Storm / 1/2" Alu Spacer / 1/8" Tempered glass

UPVC **ACCESSORIES**

PATIO DOOR HANDLES

DEDICATED TO THE HORIZON LIFT&SLIDE PATIO DOOR

A handle designed with your comfort in mind. The elongated form ensures a firm, secure grip and smooth operation of the patio door. Also available in a double-sided version to make the use of our systems even simpler and more convenient.



DEDICATED TO COMPACT PATIO DOOR

Made of aluminum, these handles are characterized by unparalleled durability. Their elegant design and ergonomic shapes enhance the appearance of any window. The handles are available in white, silver, bronze and matte black.

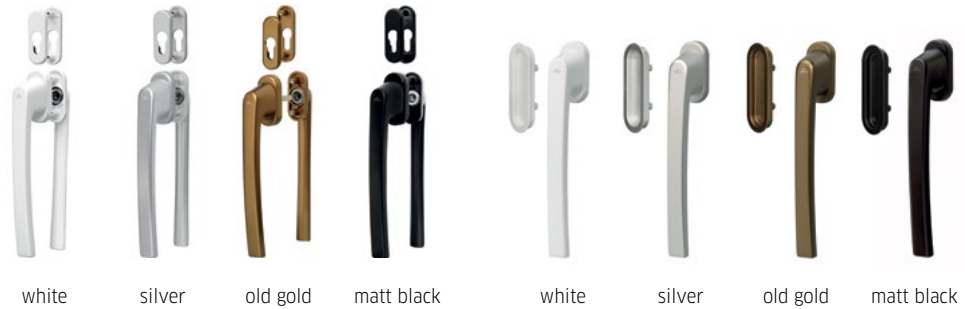

ONIX



THRESHOLDS FOR PATIO DOORS



PAVA AND PIXEL WIN STEP TRESHOLD

Low balcony threshold with a height of 0.8". Greatly facilitates the transition from the room to the balcony or terrace.



HORIZON LOW THRESHOLD 1" HEIGHT

The HORIZON low threshold compensates the disproportion and ensures comfortable use of HST MOTION S patio doors.



COMPACT STANDARD THRESHOLD 2 5/8"

The COMPACT threshold, made of durable uPVC and welded around the frame, provides exceptional weather resistance and long-term durability.



THRESHOLD IN ACCORDANCE WITH THE ADA

Our Threshold meets the American's with Disabilities Act Accessibility Guidelines (ADA). With a height of 1/2 inch applicable to veranda and balcony doors (including balcony doors with lock).



**ADA STANDARDS
COMPLIANT**

more

EFFICIENT

Is it possible to expect more? You should. At OKNOPLAST, we know that in order to provide you with a window of the highest quality, we must continually build a solid connection with our customers. The result of these strong connections is excellent patents that allow you to enjoy even more efficient systems. For example, the best acoustic and thermal insulation performance, and LOW E coating for UV protection, to name a few. Simply more benefits for you.





FEATURES

THAT MAKE YOUR LIFE

more **EFFICIENT**



GLASS OPTIONS

The available glass packages provide numerous possibilities combining security, comfort, and style. For example: tempered glass, and modern low-emission coatings that improve the overall energy balance of the home.

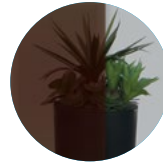

stopsol brown



stopsol clear



stopsol grey

DOUBLE-GLAZED WINDOW UNIT

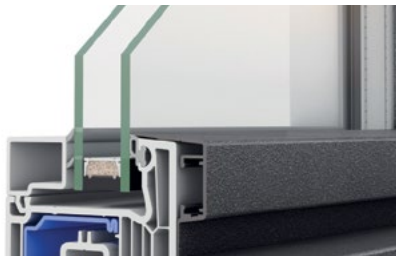

TRIPLE-GLAZED WINDOW UNIT



WARMATEC

The new Warmatec glass spacer is a combination of excellent parameters and high aesthetic value. It the formation of a thermal bridge at the interface between the glass and the frame, and consequently reduces the U_w coefficient for the entire window. Warmatec can be used in all OKNOPLAST window systems. It is available in black, brown and grey.

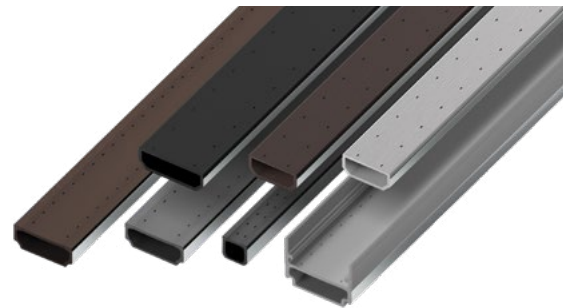

GASKETS

OKNOPLAST gaskets are characterized by high resistance to moisture, water vapor, and UV rays.



effiAIR - EFFICIENT VENTILATION

EffiAir is a new window functionality. Thanks to the separation of the sash from the frame, a 1/4 inch gap around the perimeter of the window is created. This builds a healthy indoor climate through natural ventilation. What's more, in this position the fitting still guarantees secure closure of the locked window.



- used air flows out of the room through the upper part of the window, and fresh, cool air flows in through the bottom
- fittings with ventilation*
- secure closure
- possibility to ventilate when nobody is home
- better protection against wind and rain
- no drafts or slamming windows
- healthy indoor climate thanks to natural air exchange
- fittings available in these window systems: PIXEL and PAVA
- no window screens necessary.

* Ventilation function - a way of opening the window, in which the sash is offset from the frame by about 1/4 inch around its perimeter.



Learn about the advantages of perimeter ventilation:

	Tilted window	Window with effiAIR function
Air exchange	+	+
Easy to operate	+	+
Energy efficiency		+
Anti-burglary protection		+
Noise protection / reduction		+
Protection against insects		+
Pet friendly		+
Temperature drop*		+
	35.6°F/10min	32.90°F/10min

* Source: Study of the Technical University of Münster.

UPVC WINDOWS

BRICKMOULD

Tailored exclusively for uPVC windows, this solution offers unmatched precision and durability. From easy on-site installation to perfect color matching, discover how uPVC Brickmould elevates your windows. Discover what sets uPVC Brickmould apart:

- Dedicated to uPVC windows
- Separate component, easy on-site installation
- Bottom sill option available
- Frame depth from 1 1/8" to 4 1/4"
- Tailored to window opening depth
- Precisely cut at 45° angle
- Perfect color matching between the brickmould and window
- High durability, weather-resistant
- For tilt and turn windows

Crafted exclusively for our uPVC Pava and Pixel windows, uPVC Brickmould is more than just an accessory – it's a testament to quality and innovation. Check out the 2 available options for uPVC Brickmould: one with framing on all 4 sides and the other with a windowsill.



Brickmould Tapee 3 sides and windowsill

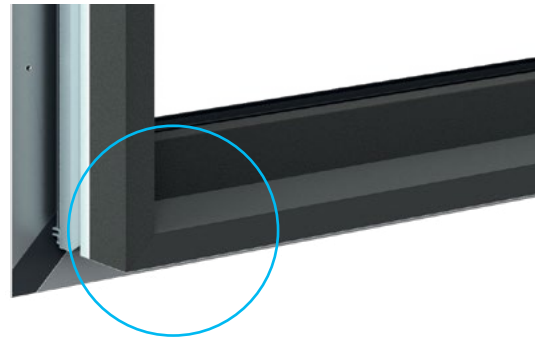

Brickmould Tapee 4 sides



BRICKMOULD DIMENSIONS:





ASSEMBLING WINDOWS TECHNIQUES

NAILING FIN INSTALLATION

- This type of installation is suitable for wooden walls where levelness, ease and safety of installation are critical.
- Anchors and screws are not needed. In short, it is used to install windows in window openings.
- Mainly used in new construction and renovations.

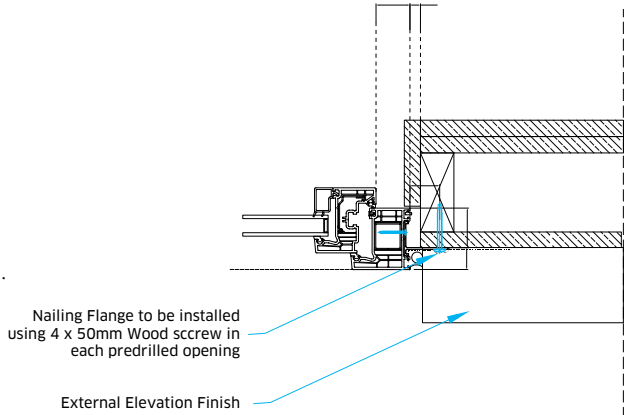

METAL CLIPS INSTALLATION

A classic method used in brick buildings where nailing or Replacement windows is not necessary.

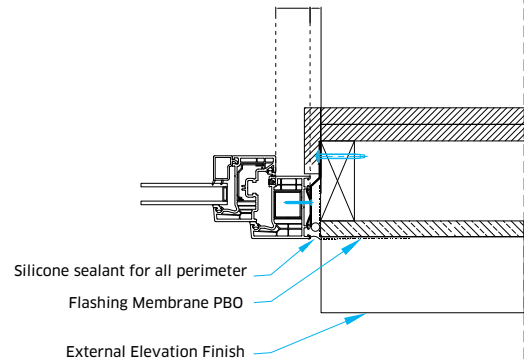

INSTALLATION ON DOWELS

- This installation method is typically effective in buildings where windows are being replaced (replacement windows).
- This is the fastest and best installation method using screws (with two types to choose from).

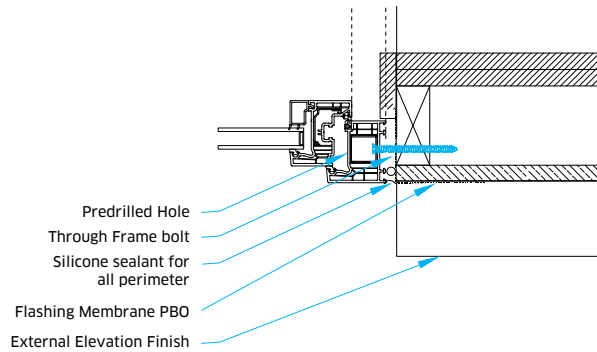

PAVA
Nailing FIN



PIXEL
Nailing FIN







more

SAFE

At OKNOPLAST, security is the foundation for designing solutions that provide comfort, stability, and carefree living. We know how to protect what is most important to you. In OKNOPLAST systems, you will find unbreakable and unforgeable security: the most secure hardware, ultra-strong steel reinforcements in the frame, a handle with a key, and high-quality details. We simply want to give you a greater sense of security.

FEATURES

THAT MAKE YOUR LIFE

more **SAFE**



WINDOW SCREENS

Window screens are matched to the type and color of the window. Thanks to the location of the screen, dirt and insects remain outside without polluting the window structure and the glass, which remains clean longer.

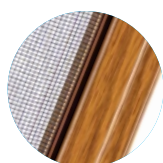

winchester

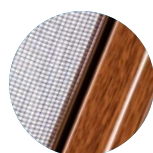

golden oak

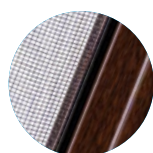

nut-brown



mahogany



white

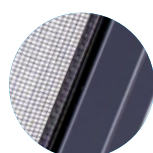

RAL 7016

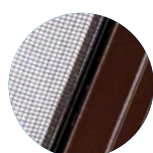

RAL 8017

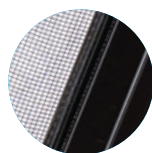

RAL 9004



UPVC **ACCESSORIES**

PLEATED WINDOW SCREEN

Is it possible to gain even more comfort? With the OKNOPLAST window screen it is. Opt for a comfortable pleated solution: easy to use and aesthetically pleasing. The screen is attached to the profile of the window and slides like an accordion, which makes it almost completely invisible when fully extended. What's more, you can slide the screen to any height, letting in as much sun as needed. The simple sliding system makes the screen extremely easy to use on a daily basis, and the sturdy aluminum construction makes it a durable solution, giving you peace of mind for years to come. It couldn't be simpler.

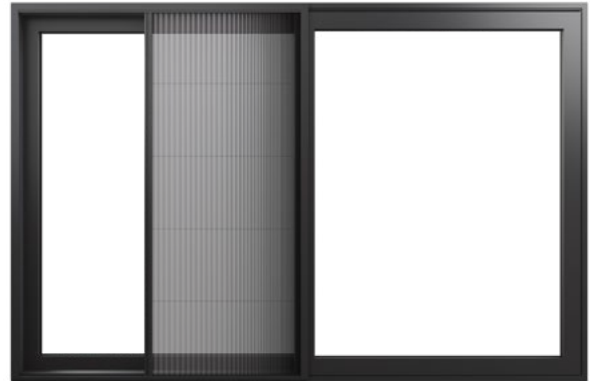

SLIDING WINDOW SCREEN

The robust construction, crafted from highly durable aluminium, boasts a sleek, modern design. Discover the SLIDE sliding mosquito screen, specifically designed for patio doors, offering you effective protection while enhancing your living space.



FITTINGS

Thanks to the use of unique solutions, OKNOPLAST fittings allow for easier operation of both window and terrace sashes. They provide safety and comfortable usage for an extensive number of years. Optional completely invisible hinges, hidden between the frame and sash, accentuate the unique shape of the window.

HIGH QUALITY

Strict manufacturing standards and high quality components make our windows and doors the first choice for customers with high expectations.



UPVC ACCESSORIES

PLEATED BLINDS

OKNOPLAST's pleated blinds offer a seamless fusion of practicality and style, serving as an elegant sun-protecting solution. These blinds effectively block sunlight, reducing both glare and heat, while providing effortless adjustability to control the desired level of light. Whether in homes or offices, these blinds offer a convenient and aesthetically pleasing way to safeguard against the sun's rays.

- Pleated blinds featuring movable top and bottom sections can be easily adjusted using a comfortable grip for convenient operation.
- Comprised of two parts that allow for versatile positioning.
- Suitable for vertical and tilt windows.
- Min. width - 4.75", max. width - 59.00"
- An eco-friendly and cost-effective solution.
- Simple assembly process

AVAILABLE VERSIONS



Comfort



Comfort Duo



Comfort Duo Integra



UPVC **ACCESSORIES**

BLIND PROFILES

Blinds up to 47 inches wide feature a standard 0.60" profile, while sizes beyond this range are equipped with a reinforced 0.72" profile. The profiles are available in 14 different colors, for a wide range of options to choose from.

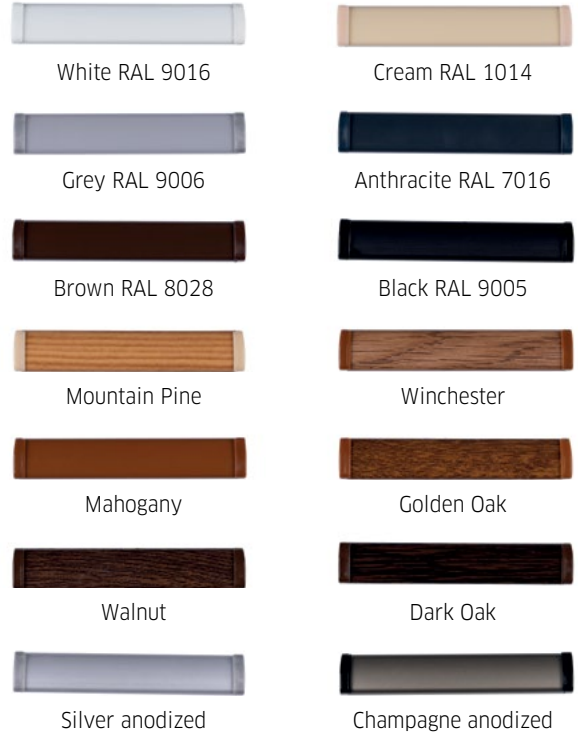

FABRIC COLLECTION

Choose from over 580 color options, various structures, patterns, degrees of darkening, and traditional or honeycomb materials, ensuring a customized solution to meet your needs.

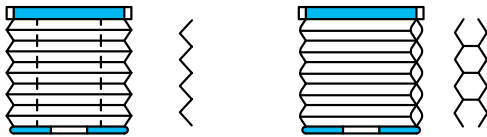

HANDLES FOR PLEATED BLINDS

The pleated blinds are operated using handles located in both the upper and lower sections. For pleats wider than 39.4 inches, two handles are provided per section. The color scheme of the handles corresponds to that of the profile.



An optional stick is available for operating the blinds in hard-to-reach positions, such as high-positioned roof windows. The stick is exclusively offered in the color white.



INSTALLATION METHOD

Typically, the pleated blinds are fastened to a glazing bead using screws, effectively covering the glass area while leaving the window sash and frame visible. To accommodate various glazing beads, the standard mounting for the pleated blinds are available in four different shapes, ensuring a flexible and adjustable fit.



UPVC FRONT DOORS



BASIC DOORS

BASIC doors work well as main entrance doors to your home or as additional backyard doors.

UPVC front doors are made of PVC door frames and a wide range of extremely durable model fillings, which make it possible for everyone to find the door of their dream home, regardless of the design or style. Customize your door with accessories or decorative glass to give it unique character. To maximize living comfort, the door is equipped with a low 0.72 inch Winstep threshold, made of aluminum and PVC. The door can also be opened and closed remotely thanks to OKNOPLAST's SMART solution. Enjoy many years of trouble-free use with the door of your dreams.

- Inside and outside opening
- Single and Double sash
- Toplight, and sidelight available
- 3 point automatic lock
- 3 door hinges
- Double and triple glazing option
- Cylinder lock or cylinder knob - 3 keys standard - key alike as an option
- Handle and pull handle options
- Option to prepare for EMTEK handle
- Option to add self closer, electric strike



**THERMAL
TRANSMITTANCE**

U-Factor = 0.27*



Smart 
OKNOPLAST

Basic doors are made on a Pixel sash 103.241 105 mm



UPVC FRONT DOORS



PREMIUM DOORS

PREMIUM doors are built with rigid profiles and reinforcements. They can be equipped with aesthetically appealing roller hinges, and are best suited for residential and commercial entrance doors.

UPVC front doors are made of PVC door frames and a wide range of extremely durable model fillings, which make it possible for everyone to find the door of their dream home, regardless of the design or style. Customize your door with accessories or decorative glass to give it unique character. To maximize living comfort, the door is equipped with a low 0.72 inch Winstep threshold, made of aluminum and PVC. The door can also be opened and closed remotely thanks to OKNOPLAST's SMART solution. Enjoy many years of trouble-free use with the door of your dreams.

- Available in Pixel or PAVA systems
- Inside and outside opening
- Single and Double sash
- Toplight, and sidelight available
- 3 point automatic lock
- 3 door hinges
- Double and triple glazing option
- Cylinder lock or cylinder knob - 3 keys standard - key alike as an option
- Handle and pull handle options
- Option to prepare for EMTEK handle
- Option to add self closer, electric strike



**THERMAL
TRANSMITTANCE**
U-Factor = 0.21-0.30*



Smart 
OKNOPLAST

PREMIUM doors are made on a Pixel sash 105.232 120 mm



FEATURES

THAT MAKE YOUR LIFE
more **BEAUTIFUL**



UNIQUE MODEL FILLINGS

A wide range of extremely durable model fillings make it possible for everyone to find the door of their dream home, regardless of the design style. There are also wide range of color combinations you can choose from.



STYLE 525

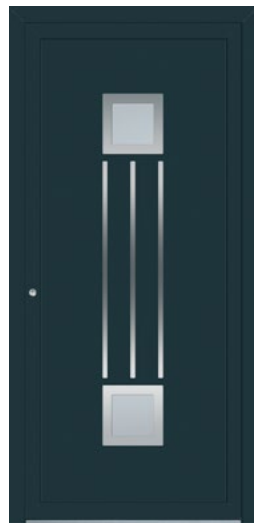

STYLE 527



STYLE 530

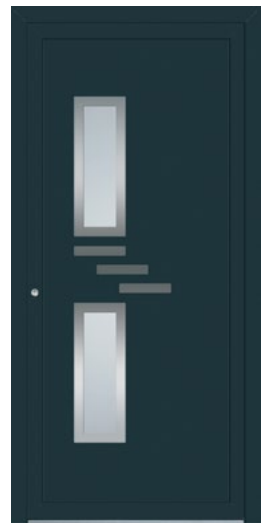

STYLE 550

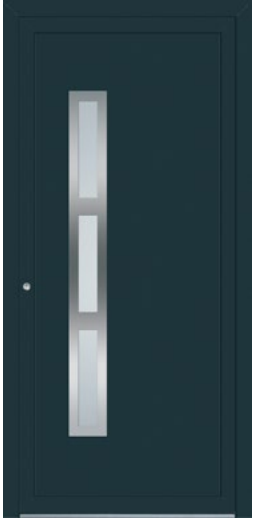

STYLE 560



STYLE 563



STYLE 565

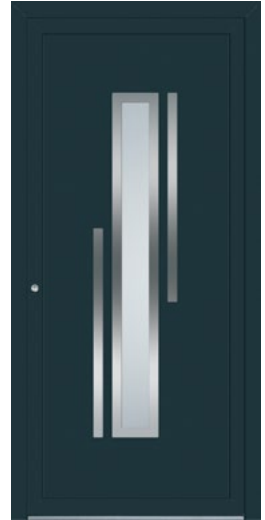

STYLE 660



STYLE 726

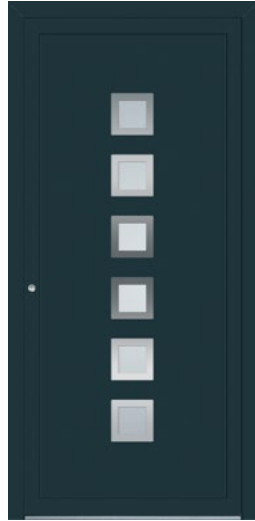

STYLE 853



STYLE 855

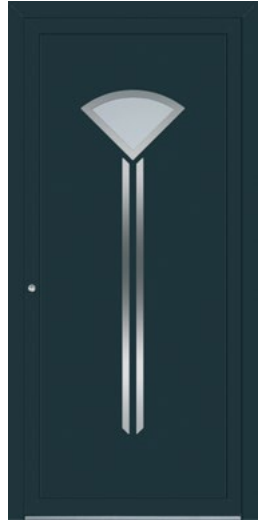

STYLE 820240

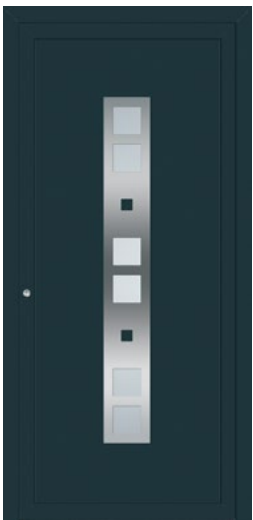

STYLE 820241



STYLE 820242



STYLE 820243



STYLE 820244

UPVC **FRONT DOORS**

FRONT DOOR HANDLES AND PULL HANDLES

A wide range of designs and colors of handles and pull handles that give the entrance an individual character*.



DOOR HANDLES FOR DOOR PREMIUM AND BASIC



G01

G03

G04

G06

G07

G11



TYPE 379763

TYPE 372000

TYPE 372253

DOOR HANDLES FOR DOOR PREMIUM



S02

S03

S07

S91

S97

* the offer also includes handles 372253.

ONIX



light gold F3

gold F4

titanium F9

silver F1

black 9005 matt

brown

white

COLORS

CLASSIC

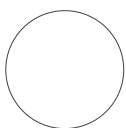

white*



brilliant white



black jet matt



dark gray



anhracite grey ALUX DB-703

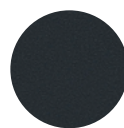

smooth anthracite grey

WOOD



sheffield oak



winchester



golden oak



walnut



anthracite wood



siena rosso

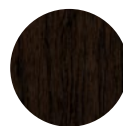

dark oak



woodec
dark toffee



OUR CERTIFICATION

Our quality and performance is confirmed by numerous European and American institutes.



MEDIA ABOUT US.



„At OKNOPLAST'S production site outside Krakow, Poland, windows of all shapes and sizes are stacked up ready for delivery - and they all have homes to go to.”



„This is just one day's production: 5000 windows by Polish company run by the new breed of entrepreneurs”



OKNOPLAST Group is a dynamically developing international company in the top of PCV window and door manufacturers in Europe.”



„OKNOPLAST is uniquely positioned [...] among the many Polish window manufacturers”.



„Operating in 10 markets, with a strong position in Italy [...] OKNOPLAST is a leading brand in the segment of PVC windows. It combines design and innovation (...).”



„In 10 years our company wants to become a global brand, a big player on many continents such as Australia, the Middle East, North America [...]”



„[...] OKNOPLAST has seen impressive growth in France: from a turnover of 2m euro in 2010 to 20m in 2013. Growth of 50% is planned for 2014”.



„Innovation has been our thing right from the start. In the history of our company we have implemented some 30 innovations”.

„OKNOPLAST was one of the first enterprises to manufacture its doors and windows in line with the CE standard EN14351:2006”.

**WARRANTY.
STRONG BRAND.
SERVICES.
DELIVERY.
QUALITY.**



OUR PRODUCTS IN COMMERCIAL AND RESIDENTIAL PROJECTS



oknoplast.us